



# Play Tower

KPL1012



Item no. KPL101201-0601

### General Product Information

Dimensions LxWxH	260x99x214 cm
Age group	1+
Play capacity (users)	4
Colour options	  

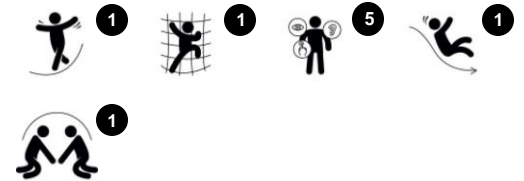

This slick, universal play tower is a thrilling venue for the rapidly developing toddler. The proportion and selection of the activities is scaled to provide optimal play stimulation for many in little space: the platform with the play panels invite play from the outside in. The loop between the ergonomic stairway and the slide mouth invites play for all children. The platform

has multiple holding points: holes in floors and stairs and sides to add grip assistance. The slide is a fun play event which additionally trains the child's sense of balance and the Spatial awareness. Both are important motor skills that help the child navigate its body securely in space. Turn-taking and cooperation skills are trained when children wait for each

other going down the slide. These are important socio-emotional skills.



# Play Tower

KPL1012



Panels of 19mm EcoCore™. EcoCore™ is a highly durable, eco friendly material, which is not only recyclable after use, but also consists of a core produced from 100% recycled material.



The main tower posts of either pine wood or aluminium are all equipped with hot dip galvanised steel footings. The steel footings elevates the posts 20mm from ground level to avoid contact with surfacing material.



Floors and panel activities are available in two types of material: Waterproof plywood decks thickness 21.5mm from pine and alder wood with anti-slip film on both sides. High Pressure Laminate HPL thickness 17.8mm with non skid surface texture according to EN 438-6.



The large hollow components are made of 100% recyclable PE. The roof displayed is moulded in one piece with minimum 5,5mm wall thickness to ensure high durability in all climates around the world.

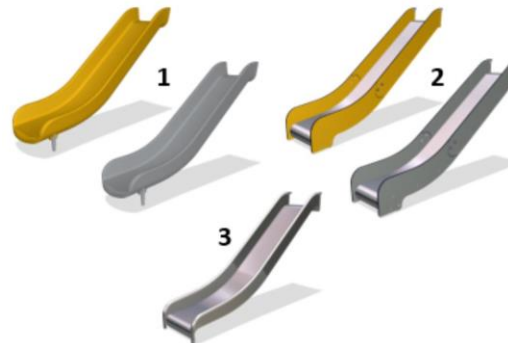

Slides are available in three different materials: moulded on piece PE slides, Combined EcoCore™ sides and stainless steel slide bed t=2mm. Full stainless steel AISI304 t=2mm.



The main tower posts are available in two types of material: Pine wood posts pressure impregnated class AB with Tanalith E3475 according to EN335. Aluminium post t=2mm with anodised surface treatment. Base material EN AW-6060 T66.

Item no. KPL101201-0601

### Installation Information

Max. fall height	100 cm
Safety surfacing area	15,5 m <sup>2</sup>
Numbers of installers (persons)	2
Total installation time	6.7
Excavation volume	0,43 m <sup>3</sup>
Concrete volume	0,00 m <sup>3</sup>
Footing depth (standard)	60 cm
Shipment weight	186 kg
Anchoring options	In-ground ✓

### Warranty Information

EcoCore HDPE	Lifetime
Post	10 years
Hollow PE parts	5 years
Plywood	5 years
Spare parts guaranteed	10 years



# Play Tower

KPL1012

\* Max fall height | \*\* Total height | \*\*\* Safety surfacing area

\* Max fall height | \*\* Total height

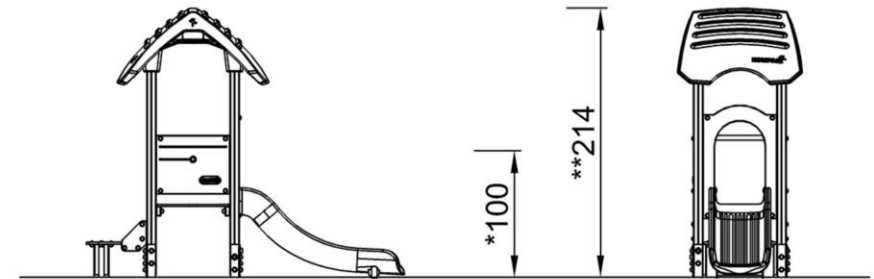
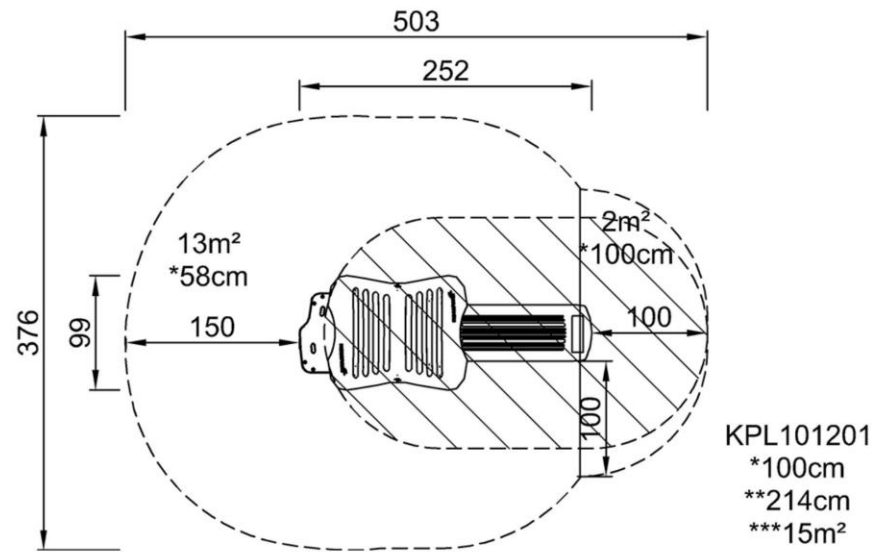

KPL101201  
1:100

[Click to see 1:100 ratio TOP VIEW](#)

# Play Tower

KPL1012



## Stairs

**Physical:** cross coordination is used, supporting the cooperation of the left and right halves of the brain, which is necessary for reading. For young children, spatial awareness is trained when walking stairs.



## Slide

**Physical:** sliding develops spatial awareness and a sense of balance. Furthermore, the core muscles are trained when sitting upright going down.  
**Social-Emotional:** empathy stimulated by turn-taking.  
**Cognitive:** young children develop their understanding of space, speed and distances when sliding down quickly.



# Play Tower

KPL1012



## PHYSICAL

Joy of movement:  
motor skills, muscle, cardio  
and bone density



## SOCIAL-EMOTIONAL

Joy of being together:  
teamwork, tolerance and  
sense of belonging



## COGNITIVE

Joy of learning:  
curiosity, understanding of causal  
relationships and knowledge of the world



## CREATIVE

Joy of creating:  
co-creation and experimenting  
with materials



### BALANCE

To balance is to stay upright when walking or standing on a surface that makes this challenging (e.g. a wobbly, inclined, or narrow surface).



### HANG IN ARMS

To hang in arms is the act of carrying the body with the hands or arms, possibly to traverse to another platform or play item.



### SENSORY

To sense is the act of taking in information with the sensory system: seeing, feeling, hearing or sensing with the body.



### BOUNCE

To bounce is the act of bouncing on a responsive, flexible, elastic or tensile surface.



### JUMP

To jump is the act of jumping up or down on a hard surface.



### SLIDE

To slide is the act of moving fast downwards seated on a slide.



### CLIMB

To climb is the act of moving upwards, cross-coordinating arms and legs, on a vertical or inclined surface or net.



### PULL

To pull is the act of pulling an item towards you or you towards an item with one or both hands, or possibly using the entire body.



### SOCIALIZE

To socialize is the act of meeting, communicating or cooperating in an activity that stimulates and facilitates social interaction.



### CONSTRUCT

To construct is the act of creating new patterns, shifting items or materials to new positions or constructing with materials that can be transformed or manipulated.



### PUSH

To push is the act of pushing an item away from you with one or both hands, possibly with the entire body.



### SPIN

To spin involves a fast, repeated horizontal or vertical turn of the body on a piece of equipment that facilitates the movement.



### CRAWL

To crawl is the movement of moving forwards or backwards, cross-coordinating arms and legs, on a horizontal or slightly inclined surface.



### ROCK

To rock is the action of rocking back and forth, or sideways, on e.g. a piece of spring equipment.



### SWAY

To sway is the movement of swaying back and forth, or around, lying, seated or possibly standing, in a pendulant or circular movement, e.g. on a hammock or on a rope.



### DRAMATIC PLAY

Dramatic play is motivated through play items that stage a frame, place or environment for acting out make believe or role play scenarios.



### ROTATE

To rotate involves a vertical or horizontal slower paced turn of the body, facilitated by a piece of equipment.



### SWING

To swing is the movement of swinging back and forth, or in circular movement, seated, standing or lying, in an unhindered arc.



### GLIDE

To glide is the act of moving from one point to another without shifting the feet, in a horizontal or vertical movement, in a seated, lying or standing position, letting gravity do the work.



### RULES PLAY

Rules play is motivated through play items that suggest games-with-rules, cooperation and team work, e.g. tic-tac-toe, timers or ball games.



### WONDER

To wonder is motivated through play items that make children need and use their logical, abstract or creative thinking skills, as well as their memory.