





Tipi Carousel

ELE400064



Item no. ELE400064-3717BL

General Product Information

Dimensions LxWxH	120x120x53 cm
Age group	4+
Play capacity (users)	6
Colour options	   

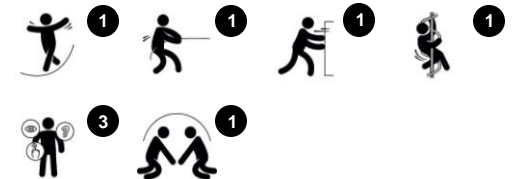

WOW! The spinning plate of the Tipi Carousel makes children laugh out with joy: It rotates, tickles the stomach and is spacious enough for a few friends, too. This will make children come back for more play again and again. The social appeal for children is evident: you can be active, and close together. There is room for more friends seated, standing or even lying.

This trains cooperation and turn-taking skills. The physical play and training in spinning is the main fun factor. The rotation trains the sense of balance which is fundamental for all other skills. A well trained sense of balance helps children to navigate the world securely, for instance preventing falls when playing actively. It also positively affects the ability to sit still and

concentrate. The Tipi Carousel is an important, responsive activity for play and active breaks.



Tipi Carousel

ELE400064



The bowls are made of recyclable PE. The bowls are moulded in one piece with integrated metal thread bushings and water drain hole to ensure high durability in all climates around the world.

Heavy duty engineered bearing system with single row deep groove ball bearings with rubber seals. The fully closed bearing construction is lifetime lubricated and maintenance free. The Bearing system has an integrated drag brake according to global safety standards.

Tipi Carousel has unique water drain system. Water drains automatically - assuring that carousel is always dry and ready to use. The water drain is covered by stainless steel strainer.

Item no. ELE400064-3717BL	
Installation Information	
Max. fall height	100 cm
Safety surfacing area	14,0 m ²
Numbers of installers (persons)	2
Total installation time	2.4
Excavation volume	0,44 m ³
Concrete volume	0,31 m ³
Footing depth (standard)	100 cm
Shipment weight	74 kg
Anchoring options	In-ground ✓ Surface ✓
Warranty Information	
Hollow PE parts	5 years
Bearing construction	5 years
Galvanised steel	10 years
Spare parts guaranteed	10 years



The Tipi Carousel is available in four different colour options.



The sand colored variant is made of rotomolded stone mixed PE material with non skid surface texture. Minor differences in the stone mix visuality of the material are to be expected.



Tipi Carousel

ELE400064

* Max fall height | ** Total height | *** Safety surfacing area

* Max fall height | ** Total height

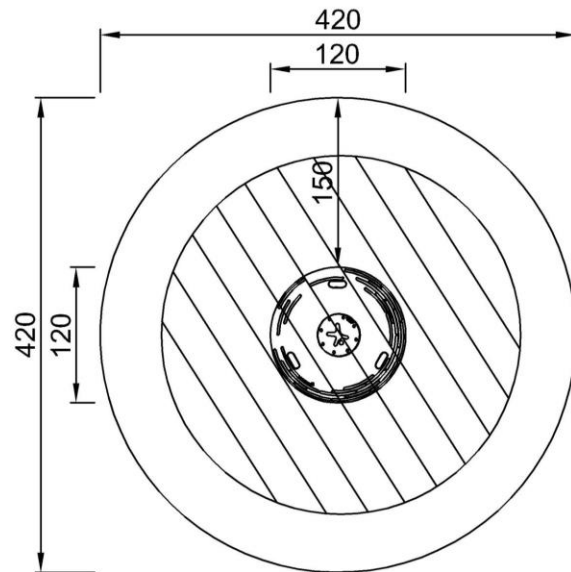

ELE400064BL
*100cm
**53cm
***14m²

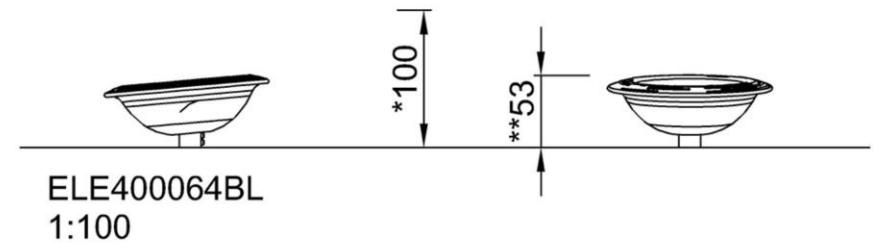

[Click to see 1:100 ratio TOP VIEW](#)

Tipi Carousel

ELE400064



Rotation

Physical: pushing or pulling it into motion, children use their muscle strength and strengthen their cardio. The rotation develops the sense of balance and space when enjoying the ride.

Social-Emotional: listening and negotiating how slow or fast to go, children develop their empathy and cooperation skills.



Spacious platform

Physical: allows for more body positions: sitting, lying, standing, which facilitates use for children with physical disabilities.

Social-Emotional: facilitates many children using the Tipi Caroussel simultaneously, training cooperation and turn-taking.



Shallow entry rim

Physical: support for entering and staying in when spinning. Eases entry for children with a range of mobility disabilities.

Social-Emotional: feeling of security when children lie or sit in Tipi Caroussel. Allows for more feeling securely seated when spinning.

Tipi Carousel

ELE400064



PHYSICAL

Joy of movement:
motor skills, muscle, cardio
and bone density



SOCIAL-EMOTIONAL

Joy of being together:
teamwork, tolerance and
sense of belonging



COGNITIVE

Joy of learning:
curiosity, understanding of causal
relationships and knowledge of the world



CREATIVE

Joy of creating:
co-creation and experimenting
with materials



BALANCE

To balance is to stay upright when walking or standing on a surface that makes this challenging (e.g. a wobbly, inclined, or narrow surface).



HANG IN ARMS

To hang in arms is the act of carrying the body with the hands or arms, possibly to traverse to another platform or play item.



SENSORY

To sense is the act of taking in information with the sensory system: seeing, feeling, hearing or sensing with the body.



BOUNCE

To bounce is the act of bouncing on a responsive, flexible, elastic or tensile surface.



JUMP

To jump is the act of jumping up or down on a hard surface.



SLIDE

To slide is the act of moving fast downwards seated on a slide.



CLIMB

To climb is the act of moving upwards, cross-coordinating arms and legs, on a vertical or inclined surface or net.



PULL

To pull is the act of pulling an item towards you or you towards an item with one or both hands, or possibly using the entire body.



SOCIALIZE

To socialize is the act of meeting, communicating or cooperating in an activity that stimulates and facilitates social interaction.



CONSTRUCT

To construct is the act of creating new patterns, shifting items or materials to new positions or constructing with materials that can be transformed or manipulated.



PUSH

To push is the act of pushing an item away from you with one or both hands, possibly with the entire body.



SPIN

To spin involves a fast, repeated horizontal or vertical turn of the body on a piece of equipment that facilitates the movement.



CRAWL

To crawl is the movement of moving forwards or backwards, cross-coordinating arms and legs, on a horizontal or slightly inclined surface.



ROCK

To rock is the action of rocking back and forth, or sideways, on e.g. a piece of spring equipment.



SWAY

To sway is the movement of swaying back and forth, or around, lying, seated or possibly standing, in a pendulant or circular movement, e.g. on a hammock or on a rope.



DRAMATIC PLAY

Dramatic play is motivated through play items that stage a frame, place or environment for acting out make believe or role play scenarios.



ROTATE

To rotate involves a vertical or horizontal slower paced turn of the body, facilitated by a piece of equipment.



SWING

To swing is the movement of swinging back and forth, or in circular movement, seated, standing or lying, in an unhindered arc.



GLIDE

To glide is the act of moving from one point to another without shifting the feet, in a horizontal or vertical movement, in a seated, lying or standing position, letting gravity do the work.



RULES PLAY

Rules play is motivated through play items that suggest games-with-rules, cooperation and team work, e.g. tic-tac-toe, timers or ball games.



WONDER

To wonder is motivated through play items that make children need and use their logical, abstract or creative thinking skills, as well as their memory.