

Dragite

COR47330

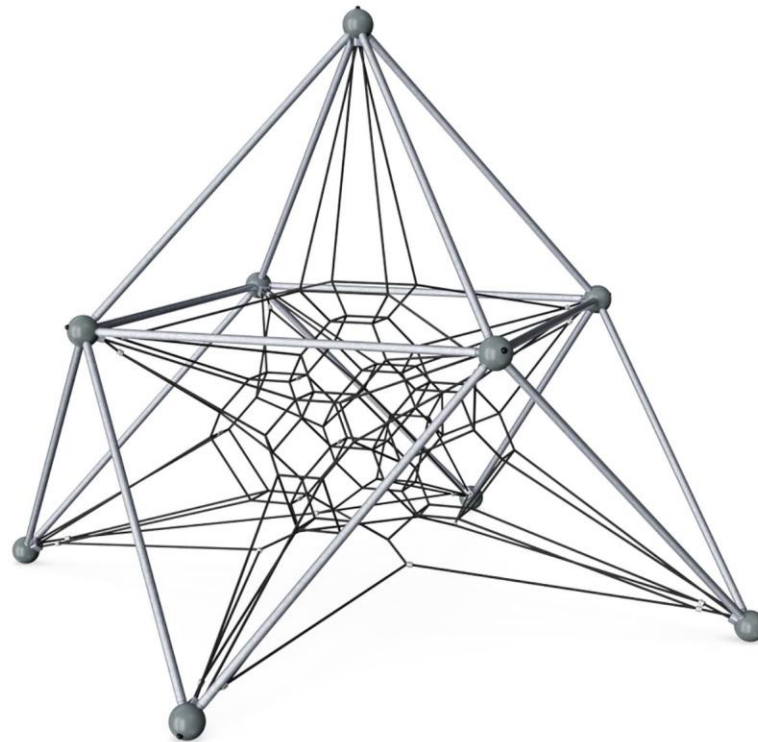

Item no. COR473301-0406	
General Product Information	
Dimensions LxWxH	437x437x436 cm
Age group	3+
Play capacity (users)	28
Colour options	

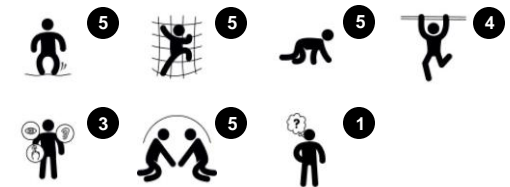

The responsive, bouncy ropes and nets of the Dragite attracts children hugely. The varied climbing and meeting options make them want to come back again and again. The transparency of the nets make communication possible across the net. The symmetry of the net cubes supports climbing for younger or less confident climbers, and variation for all. The

side ropes function as meeting and retraction spots in the climbing landscape and make possible hanging in arms, training upper body muscles. This is important to children today, as they lead increasingly sedentary lifestyles. Concentration is needed when climbing, as the ropes are interconnected and reflect the movements of all climbers, throughout the net.

This trains the muscles, cross-body coordination and spatial awareness, important for security in motion.

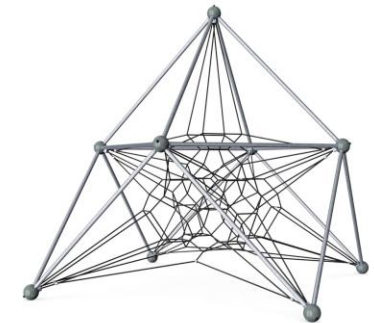

Dragite

COR47330



Corocord 'S' clamps are used as universal connections in Corocord products. 8mm stainless steel rods with rounded edges are pressed around the ropes with a special hydraulic press, making them the ideal connector: safe, durable and vandalism-proof, all while allowing the typical movement of rope climbing structures.

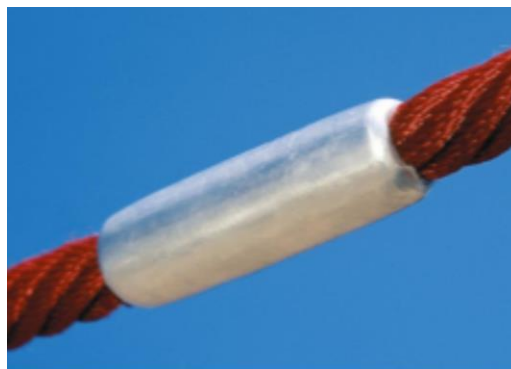

The aluminium swages of the net are double conical with rounded ends and are as small as safety allows. The overall net design aims at keeping metal parts within the net to an absolute minimum, both in size and number, in order to provide the best possible rope climbing experience.

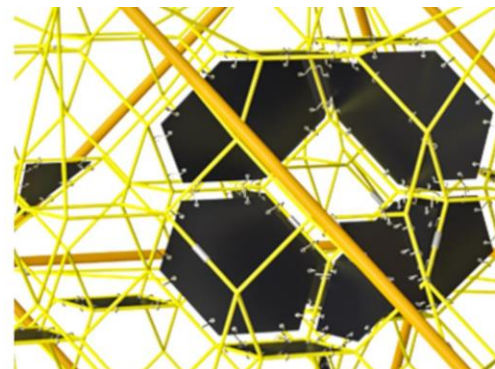

Corocord membranes consist of friction-proof rubberized material of conveyor belt quality with excellent UV resistance. Tested and compliant with REACH requirements for PAH. Embedded is a four-layered armouring made of woven polyester. The armouring and the two surface layers result in a total thickness of 7.5 mm.



The steel struts are hot dip galvanised inside and outside with lead free zinc. The galvanisation has excellent corrosion resistance in outside environments and requires low maintenance.

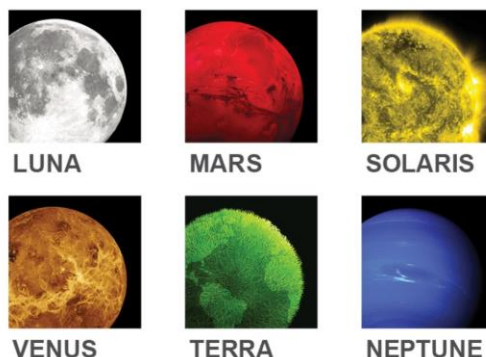

The COROCORD Frame Nets are available in 6 galactic colour themes. The themes draw on bright colours that appeal to children of all ages. Can be changed in the configurator.

Item no. COR473301-0406	
Installation Information	
Max. fall height	230 cm
Safety surfacing area	57,4 m ²
Numbers of installers (persons)	2
Total installation time	14.9
Excavation volume	1,76 m ³
Concrete volume	0,98 m ³
Footing depth (standard)	120 cm
Shipment weight	597 kg
Anchoring options	In-ground ✓
Warranty Information	
EcoCore HDPE	Lifetime
Corocord rope	5 years
S-Clamps	10 years
Galvanised steel	10 years
Spare parts guaranteed	10 years



Dragite

COR47330

* Max fall height | ** Total height | *** Safety surfacing area

* Max fall height | ** Total height

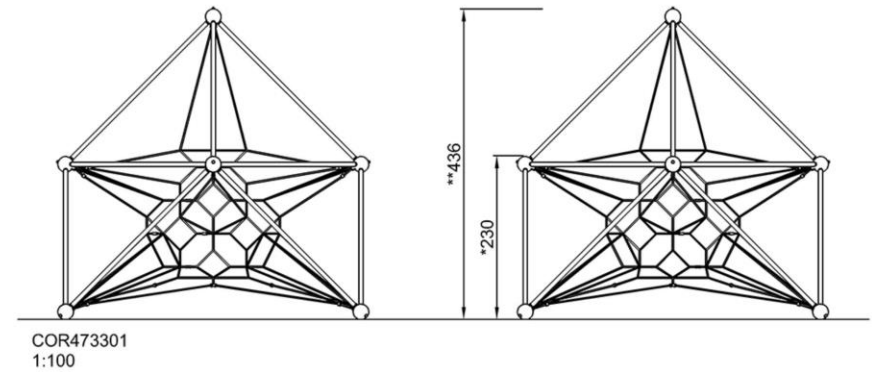
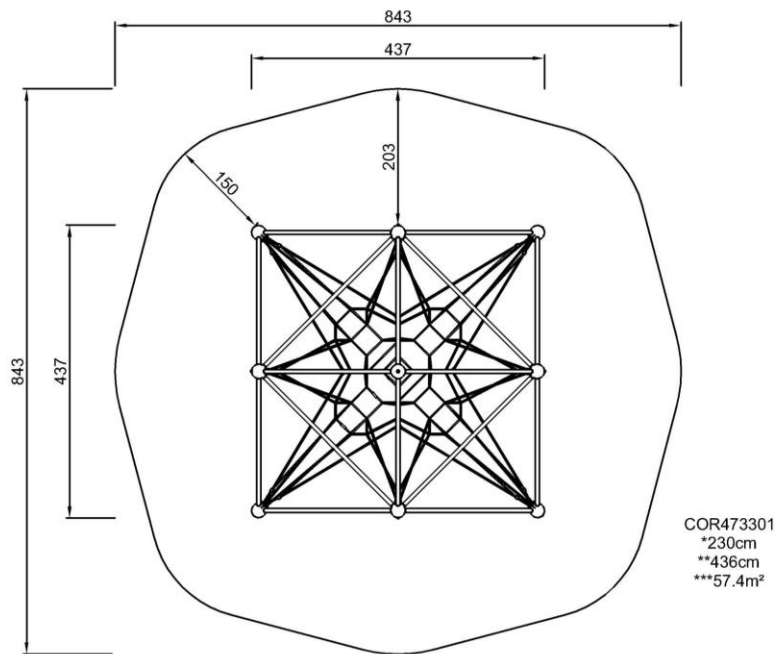

[Click to see 1:100 ratio TOP VIEW](#)



Transparency

Social-Emotional: the transparency makes possible cooperation and communication throughout, all important life-skills for children to learn.



Height

Social-Emotional: children develop courage and self-regulation when being up high. This positively affects self-confidence.

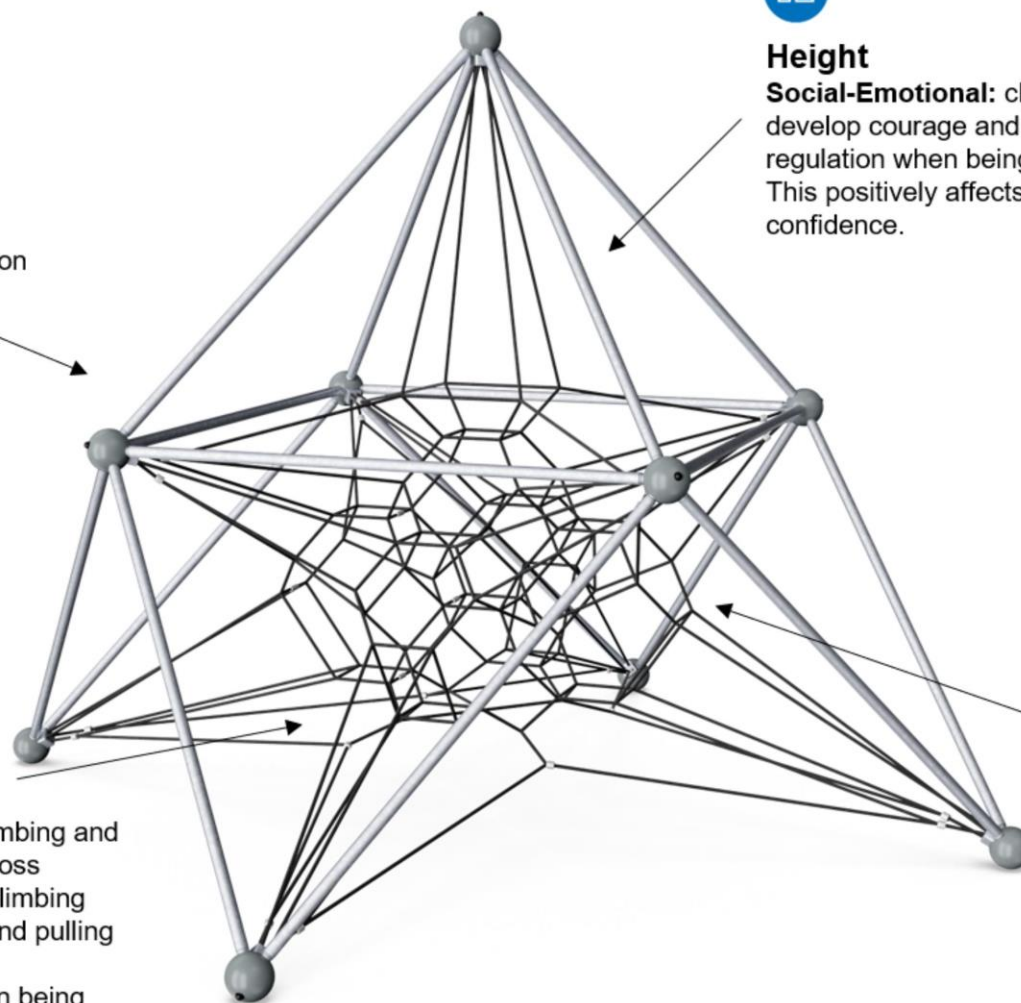

Big meshes

Physical: the big meshes allow for climbing and crawling, supporting proprioception, cross coordination and spatial awareness. Climbing here takes muscle strength, pushing and pulling arms to get upwards.

Social-Emotional: allow more children being seated together, sharing.



Connected nets

Physical: the connected nets make the climbers feel the movements of the other climbers, adding a dimension of fun and demanding concentration when holding tight to the rope. All muscle groups are trained, as well as cross coordination.

Social-Emotional: the climbers' movements affect the other climbers, so consideration and turn-taking is supported.

Cognitive: cause and effect understanding is supported by the bouncing effect of the movement of others.

Dragite

COR47330



PHYSICAL

Joy of movement:
motor skills, muscle, cardio
and bone density



SOCIAL-EMOTIONAL

Joy of being together:
teamwork, tolerance and
sense of belonging



COGNITIVE

Joy of learning:
curiosity, understanding of causal
relationships and knowledge of the world



CREATIVE

Joy of creating:
co-creation and experimenting
with materials



BALANCE

To balance is to stay upright when walking or standing on a surface that makes this challenging (e.g. a wobbly, inclined, or narrow surface).



HANG IN ARMS

To hang in arms is the act of carrying the body with the hands or arms, possibly to traverse to another platform or play item.



SENSORY

To sense is the act of taking in information with the sensory system: seeing, feeling, hearing or sensing with the body.



BOUNCE

To bounce is the act of bouncing on a responsive, flexible, elastic or tensile surface.



JUMP

To jump is the act of jumping up or down on a hard surface.



SLIDE

To slide is the act of moving fast downwards seated on a slide.



CLIMB

To climb is the act of moving upwards, cross-coordinating arms and legs, on a vertical or inclined surface or net.



PULL

To pull is the act of pulling an item towards you or you towards an item with one or both hands, or possibly using the entire body.



SOCIALIZE

To socialize is the act of meeting, communicating or cooperating in an activity that stimulates and facilitates social interaction.



CONSTRUCT

To construct is the act of creating new patterns, shifting items or materials to new positions or constructing with materials that can be transformed or manipulated.



PUSH

To push is the act of pushing an item away from you with one or both hands, possibly with the entire body.



SPIN

To spin involves a fast, repeated horizontal or vertical turn of the body on a piece of equipment that facilitates the movement.



CRAWL

To crawl is the movement of moving forwards or backwards, cross-coordinating arms and legs, on a horizontal or slightly inclined surface.



ROCK

To rock is the action of rocking back and forth, or sideways, on e.g. a piece of spring equipment.



SWAY

To sway is the movement of swaying back and forth, or around, lying, seated or possibly standing, in a pendulant or circular movement, e.g. on a hammock or on a rope.



DRAMATIC PLAY

Dramatic play is motivated through play items that stage a frame, place or environment for acting out make believe or role play scenarios.



ROTATE

To rotate involves a vertical or horizontal slower paced turn of the body, facilitated by a piece of equipment.



SWING

To swing is the movement of swinging back and forth, or in circular movement, seated, standing or lying, in an unhindered arc.



GLIDE

To glide is the act of moving from one point to another without shifting the feet, in a horizontal or vertical movement, in a seated, lying or standing position, letting gravity do the work.



RULES PLAY

Rules play is motivated through play items that suggest games-with-rules, cooperation and team work, e.g. tic-tac-toe, timers or ball games.



WONDER

To wonder is motivated through play items that make children need and use their logical, abstract or creative thinking skills, as well as their memory.