



# Arch Ladder, 2.0m high

COR20210



Item no. COR202101-0301

## General Product Information

Dimensions LxWxH	439x105x200 cm
Age group	5+
Play capacity (users)	20
Colour options	 

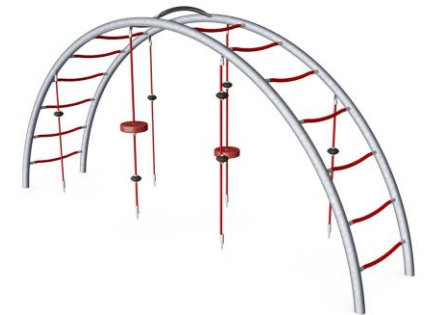
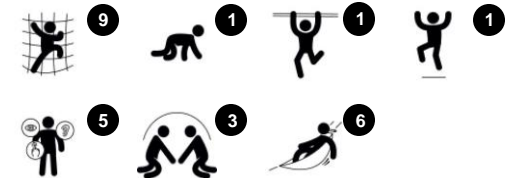

The Large Arc Ladder is an appealing climbing and meeting structure for the youngest players. The versatile climbing opportunities; up, down, through and across will attract children to return to play, again and again. The swaying ropes with seats and UFO's invite vertical climbing as well as a swaying rest with friends, seated or standing which stimulates social interaction.

The arc ladder makes a nice climb to the top, where children can get a great view from above. Apart from having great fun exploring play possibilities, children develop their cross-coordination and muscle strength when climbing and when passing others when climbing through trains turn-taking skills and consideration. These varied climbing

possibilities make it possible for both timid and courageous children to experience successful play and participate which is important for positive self perception.

# Arch Ladder, 2.0m high

COR20210

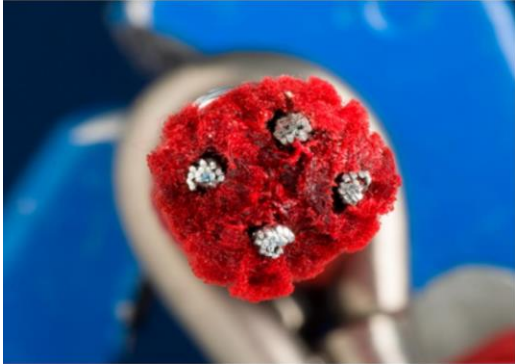

Corocord 16mm ropes are special 'Hercules'-type with galvanized four-stranded steel wires and a steel wire core. Each strand is tightly wrapped with PES yarn, which is melted onto each individual strand. The ropes are highly wear-and-vandalism-resistant and can be replaced at site if needed.



The steel structure are hot dip galvanized inside and outside with lead free zinc. The galvanisation has excellent corrosion resistance in outside environments and requires low maintenance.



Fully coloured EPDM rubber discs with smooth surface. The moulded EPDM surrounds a hot dip galvanized steel core that ensures both the stability of the discs and durable fixation to the rope.

Item no. COR202101-0301	
Installation Information	
Max. fall height	200 cm
Safety surfacing area	28,0 m <sup>2</sup>
Numbers of installers (persons)	2
Total installation time	5.9
Excavation volume	2,38 m <sup>3</sup>
Concrete volume	1,70 m <sup>3</sup>
Footing depth (standard)	90 cm
Shipment weight	171 kg
Anchoring options	In-ground ✓ Surface ✓
Warranty Information	
Corocord rope	5 years
S-Clamps	10 years
Galvanised steel	10 years
EPDM components	2 years
Spare parts guaranteed	10 years



# Arch Ladder, 2.0m high

COR20210

\* Max fall height | \*\* Total height | \*\*\* Safety surfacing area

\* Max fall height | \*\* Total height

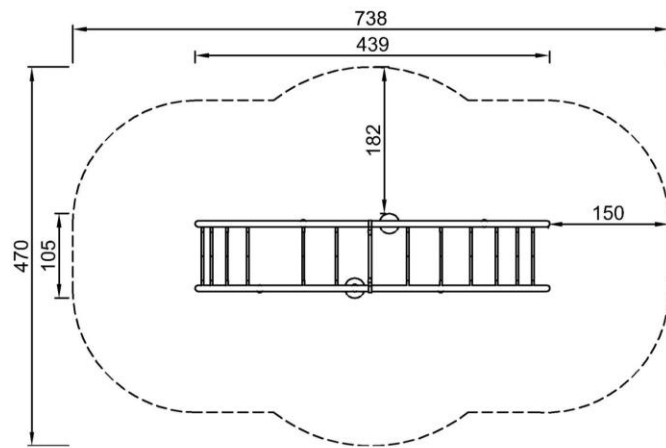

COR202101-xx01  
\*200cm  
\*\*200cm  
\*\*\*28.0m<sup>2</sup>

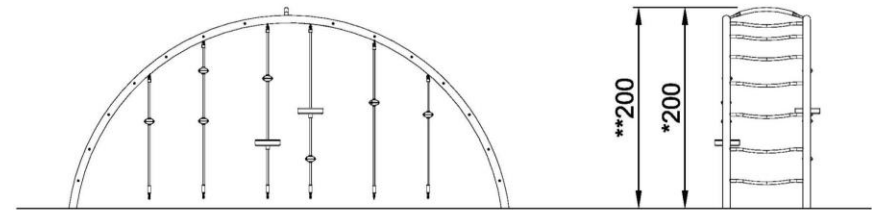

COR202101  
1:100

[Click to see 1:100 ratio TOP VIEW](#)

# Arch Ladder, 2.0m high

COR20210



## Frame

**Physical:** develop children's upper body muscles and arm strength when hanging from arms. This is especially important due to sedentary lifestyles and back-pain in children.

**Social-Emotional:** develop children's turn-taking skills and empathy when passing others on the top frame.

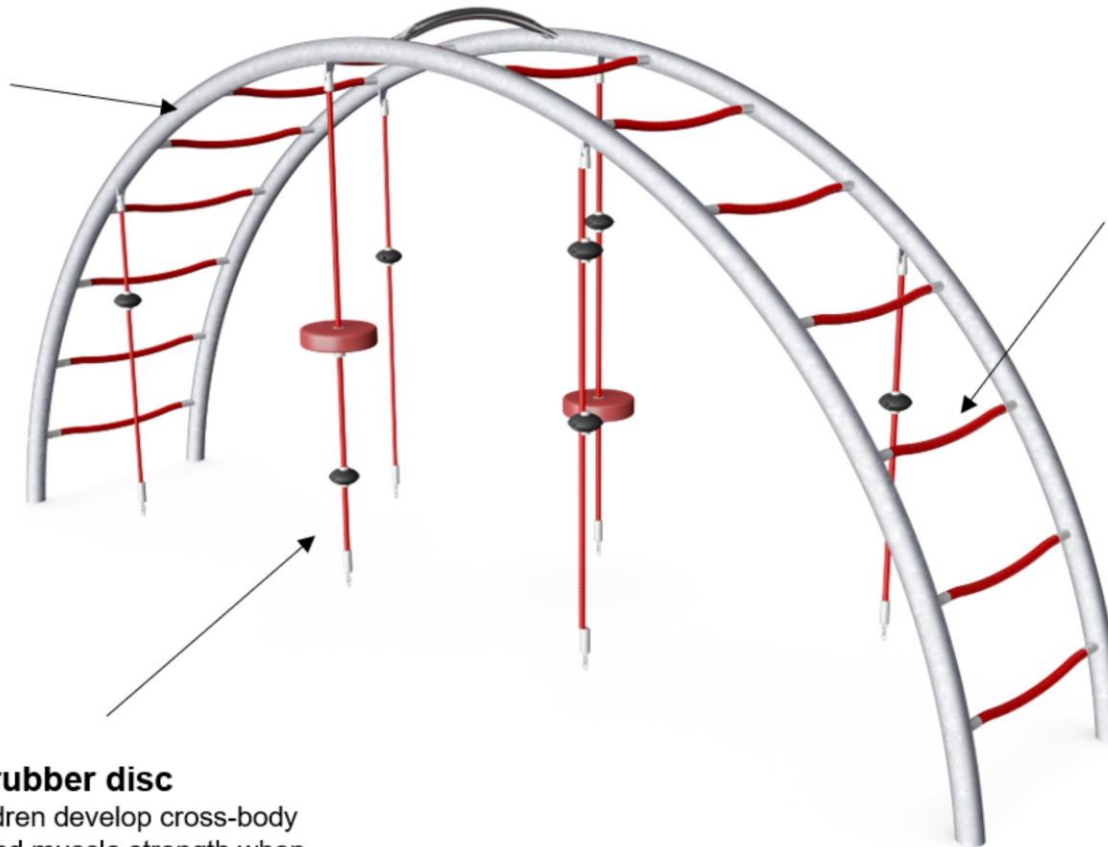

## Rope ladder

**Physical:** the big steps allow for climbing and crawling through, supporting proprioception and spatial awareness. Climbing here takes big steps, developing cross coordination and muscle strength, arms pulling to get upwards.

**Social-Emotional:** the big meshes allow more children being seated together, sharing.



## Rope with rubber disc

**Physical:** children develop cross-body coordination and muscle strength when stepping onto the disc and climbing the rope. Their sense of balance is trained when swaying gently. The sense of balance is important for instance for being able to sit still.

**Social-Emotional:** socializing and turn-taking when deciding who should sit here.

# Arch Ladder, 2.0m high

COR20210



**PHYSICAL**  
Joy of movement:  
motor skills, muscle, cardio  
and bone density



**SOCIAL-EMOTIONAL**  
Joy of being together:  
teamwork, tolerance and  
sense of belonging



**COGNITIVE**  
Joy of learning:  
curiosity, understanding of causal  
relationships and knowledge of the world



**CREATIVE**  
Joy of creating:  
co-creation and experimenting  
with materials



**BALANCE**  
To balance is to stay upright when walking or standing on a surface that makes this challenging (e.g. a wobbly, inclined, or narrow surface).



**HANG IN ARMS**  
To hang in arms is the act of carrying the body with the hands or arms, possibly to traverse to another platform or play item.



**SENSORY**  
To sense is the act of taking in information with the sensory system: seeing, feeling, hearing or sensing with the body.



**BOUNCE**  
To bounce is the act of bouncing on a responsive, flexible, elastic or tensile surface.



**JUMP**  
To jump is the act of jumping up or down on a hard surface.



**SLIDE**  
To slide is the act of moving fast downwards seated on a slide.



**CLIMB**  
To climb is the act of moving upwards, cross-coordinating arms and legs, on a vertical or inclined surface or net.



**PULL**  
To pull is the act of pulling an item towards you or you towards an item with one or both hands, or possibly using the entire body.



**SOCIALIZE**  
To socialize is the act of meeting, communicating or cooperating in an activity that stimulates and facilitates social interaction.



**CONSTRUCT**  
To construct is the act of creating new patterns, shifting items or materials to new positions or constructing with materials that can be transformed or manipulated.



**PUSH**  
To push is the act of pushing an item away from you with one or both hands, possibly with the entire body.



**SPIN**  
To spin involves a fast, repeated horizontal or vertical turn of the body on a piece of equipment that facilitates the movement.



**CRAWL**  
To crawl is the movement of moving forwards or backwards, cross-coordinating arms and legs, on a horizontal or slightly inclined surface.



**ROCK**  
To rock is the action of rocking back and forth, or sideways, on e.g. a piece of spring equipment.



**SWAY**  
To sway is the movement of swaying back and forth, or around, lying, seated or possibly standing, in a pendulant or circular movement, e.g. on a hammock or on a rope.



**DRAMATIC PLAY**  
Dramatic play is motivated through play items that stage a frame, place or environment for acting out make believe or role play scenarios.



**ROTATE**  
To rotate involves a vertical or horizontal slower paced turn of the body, facilitated by a piece of equipment.



**SWING**  
To swing is the movement of swinging back and forth, or in circular movement, seated, standing or lying, in an unhindered arc.



**GLIDE**  
To glide is the act of moving from one point to another without shifting the feet, in a horizontal or vertical movement, in a seated, lying or standing position, letting gravity do the work.



**RULES PLAY**  
Rules play is motivated through play items that suggest games-with-rules, cooperation and team work, e.g. tic-tac-toe, timers or ball games.



**WONDER**  
To wonder is motivated through play items that make children need and use their logical, abstract or creative thinking skills, as well as their memory.